



Evaluation and Prediction of Production Yields in Plastic Manufacturing Industry Using Artificial Neural Network

**Akaolisa Chukwuebuka C. ^a, Iweriolor Sunday ^b,
Uzochukwukanma M. C. ^a, Ezeliora C. D. ^{a*}
and Umeh Maryrose N. ^c**

^a Industrial and Production Engineering, Nnamdi Azikiwe University, Awka, Anambra State, Nigeria.

^b Department of Mechanical Engineering, University of delta, Agbor, Delta State, Nigeria.

^c Department of Computer Science, Nnamdi Azikiwe University, Awka, Anambra State, Nigeria.

Authors' contributions

This work was carried out in collaboration among all authors. All authors read and approved the final manuscript.

Article Information

DOI: 10.9734/JERR/2023/v25i111026

Open Peer Review History:

This journal follows the Advanced Open Peer Review policy. Identity of the Reviewers, Editor(s) and additional Reviewers, peer review comments, different versions of the manuscript, comments of the editors, etc are available here:

<https://www.sdiarticle5.com/review-history/109393>

Original Research Article

Received: 13/09/2023

Accepted: 20/11/2023

Published: 27/11/2023

ABSTRACT

The study focused on the evaluation and prediction of a production yield in Finoplastika plastic manufacturing industry. The study investigates the need of prediction and continuous improvement of production plastic yield in manufacturing industries. The literature reveals the related research works in manufacturing industries and found a gap in application of predictive tools to appraise the plastic production yield in the case company. The use of artificial neural network serves as the method of data analysis applied to achieve the aim of this study. The application of artificial neural network for the predicted solutions of the response variables of 110mm waste plastic pipe, 20mm

*Corresponding author: Email: cezeliora@gmail.com, cezeliora@googlemail.com;

pressure plastic pipe, 50mm waste plastic pipe and 32mm pressure plastic pipe are 31149, 45171, 13412, and 12891 respectively. The results for predicted solutions are recommended to the case company and other plastic companies for their wider use and applicability in other to achieve their optimal results and to support decision making during, inventory system, production process, production planning and control.

Keywords: Plastic; artificial neural network (ANN); prediction; manufacturing; production process.

1. INTRODUCTION

The objective of various organizations, companies or firms is to make profit as that is what guarantees its continuous existence and productivity. Today, manufacturing industries at all levels are challenged to produce goods of the right quality, quantity and timing at minimum cost and maximum profit for their survival and growth. Therefore, this requires an increase in the productive efficiency of the industry. Optimization is a way of life [1,2,3]. Plastic is a synthetic material made from a wide range of organic polymers, which can be molded into various shapes and forms. Plastic is widely used in modern society due to its durability, versatility, and low cost of production. Some common uses of plastic include packaging materials, consumer goods, and industrial products. Plastic is typically made from fossil fuels, such as petroleum or natural gas, which are refined and processed to produce the raw materials for plastic production. The production process can have significant environmental impacts, including the release of greenhouse gases and pollution of waterways and oceans. One of the main challenges associated with plastic is its persistence in the environment [4,5]. Many types of plastic do not biodegrade and can persist in the environment for hundreds of years. This can have negative impacts on wildlife and ecosystems, as well as human health. Efforts are underway to develop more sustainable alternatives to traditional plastic, such as biodegradable materials and renewable energy sources [2,6] (Ejikeme and Ezeliora, 2016). Additionally, there is increasing awareness and advocacy around reducing single-use plastics and transitioning to more sustainable packaging alternatives [4,5,7]. Plastic production refers to the process of creating synthetic polymers that are used to manufacture various plastic products, including packaging materials, consumer goods, and industrial products. The production process typically involves the use of fossil fuels, such as petroleum, natural gas, or coal, as feedstock, which are then converted into various forms of plastic through chemical reactions [5,7]. The

production of plastic has increased dramatically since the 1950s, with estimates suggesting that more than 8.3 billion metric tons of plastic have been produced worldwide. However, plastic production and disposal have significant environmental impacts, including pollution of oceans and waterways, release of greenhouse gases, and depletion of non-renewable resources. To address these issues, efforts are underway to develop more sustainable plastic production and disposal methods, such as recycling and the use of biodegradable materials. Additionally, there is increasing awareness and advocacy around reducing single-use plastics and transitioning to more sustainable packaging alternatives [4,5]. Plastic production involves the manufacturing of various plastic products that are widely used in our daily lives. Plastics are synthetic polymers that can be easily molded into different shapes and sizes, making them useful in several applications such as packaging, transportation, construction, and electronics. The process of plastic production involves several steps, including the production of raw materials, polymerization of monomers into plastic resins, and forming these resins into different products. Plastic production has significantly increased over the years, with global production rising from 1.5 million tons in 1950 to over 360 million tons in 2019 [7]. While plastics have numerous advantages such as being lightweight, durable, and flexible, they also pose significant environmental challenges, especially in terms of waste and pollution. Plastic waste can pollute oceans, harm wildlife, and pose a risk to human health, which has led to concerns about the environmental impact of plastic production. As a result, there is a growing need to promote sustainable plastic production and reduce plastic waste through initiatives such as recycling, biodegradable plastics, and alternative materials. These initiatives can help mitigate the environmental impact of plastic production and ensure a more sustainable future. Plastic production is a critical industry that plays a significant role in our modern economy. However, the environmental challenges associated with plastic waste require careful

consideration and action to promote sustainable production practices and reduce the negative impact of plastic on the environment. Plastic production is a complex process that involves several stages, including raw material extraction, refining, and polymerization. The production process deals with transforming a series of inputs into those products. This involves two focal sets of resources: transformative resources and transformed resources. Transformative resources include the buildings, machinery, computers, and people who carry out the transformative processes. The transformed resources are the raw materials and components that are transformed into final products. Any production process involves a series of links in a production chain. At each stage value is added in the course of production. Adding value involves making a product more desirable to the consumer so that they pay more for it. Therefore, adding value is not just about manufacturing, it includes the marketing process, including advertising, promotion, and distribution that make the end product more desirable. It is very important for businesses to identify the processes that add value, so that they can enhance these processes to the ongoing benefit of the business. Production is essential for economic growth, prosperity and a higher standard of living. It is a catalyst for industrial and economic development. It satisfies the economic needs of individuals, communities, and nations by producing things in workshops using men, materials, machines, money, and methods [8]. Essentially, manufacturing can be defined simply as value-added processes whereby raw materials of low utility and value due to inadequate material properties and poor irregular size, shape and finish are converted into high utility and value products with dimensions, shapes and sizes, defined finishes certain functional capacity through the use of resources [9]. The resources could be people, machines, computers and/or organized integration of one or more of the above mentioned (Kizito, 2015). To realize higher efficiency, there must be optimal [10] allocation of these resources to activities of production. However, the aim of this work is to investigate and to predict the plastic pipe production quantities using artificial neural network.

1.1 Mathematical Optimization

“In mathematics, computer science, and operations research, mathematical optimization (alternatively, mathematical optimization or

programming) is the selection of a best item (with respect to some criteria) from some set of available alternatives” (Erwin, 2008). “In the simplest case, an optimization problem consists of maximizing or minimizing a real function by systematically choosing input values within a permitted set and calculating the value of the function. Generalization of optimization theory and techniques to other formulations encompasses a large area of applied mathematics. More generally, optimization includes finding the "best available" values of some objective function given a defined domain (or set of constraints), including a variety of different types of objective functions and different types of domains” [1,2].

1.2 Artificial Neural Network

The term ‘Neural’ has origin from the human (animal) nervous system’s basic functional unit ‘neuron’ or nerve cells present in the brain and other parts of the human (animal) body. A neural network is a group of algorithms that certify the underlying relationship in a set of data similar to the human brain. The neural network helps to change the input so that the network gives the best result without redesigning the output procedure [11]. “These are computational models and inspire by the human brain. Many of the recent advancements have been made in the field of Artificial Intelligence, including Voice Recognition, Image Recognition, and Robotics using it” [12]. They are the biologically inspired simulations performed on the computer to perform certain specific tasks like – Clustering, Classification, and Pattern Recognition.

“In general, artificial neural network is a biologically inspired network of artificial neurons configured to perform specific tasks. These biological methods of computing are known as the next major advancement in the Computing Industry” [12,13].

The connections can be inhibitory (decreasing strength) or excitatory (increasing strength) in nature. So, a neural network, in general, has a connected network of billions of neurons with a trillion of interconnections between them [12].

1.3 Artificial Neural Networks and its Applications

As you read this article, which organ in your body is thinking about it? It’s the brain of course! But do you know how the brain works? Well, it has

neurons or nerve cells that are the primary units of both the brain and the nervous system. These neurons receive sensory input from the outside world which they process and then provide the output which might act as the input to the next neuron.

“Each of these neurons is connected to other neurons in complex arrangements at synapses. Now, are you wondering how this is related to Artificial Neural Networks? Well, Artificial Neural Networks are modeled after the neurons in the human brain. Let’s check out what they are in detail and how they learn information” [14]. “Artificial Neural Networks contain artificial neurons which are called units. These units are arranged in a series of layers that together constitute the whole Artificial Neural Network in a system. A layer can have only a dozen units or millions of units as this depend on how the complex neural networks will be required to learn the hidden patterns in the dataset. Commonly, Artificial Neural Network has an input

layer, an output layer as well as hidden layers. The input layer receives data from the outside world which the neural network needs to analyze or learn about. Then this data passes through one or multiple hidden layers that transform the input into data that is valuable for the output layer. Finally, the output layer provides an output in the form of a response of the Artificial Neural Networks to input data provided” [14]. In the majority of neural networks, units are interconnected from one layer to another. Each of these connections has weights that determine the influence of one unit on another unit. As the data transfers from one unit to another, the neural network learns more and more about the data which eventually results in an output from the output layer. The structures and operations of human neurons serve as the basis for artificial neural networks. It is also known as neural networks or neural nets. The input layer of an artificial neural network is the first layer, and it receives input from external sources and

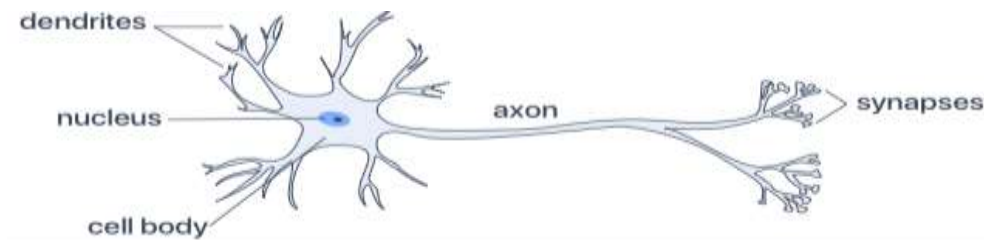

Fig. 1. Biological Neuron

Table 1. The difference between Artificial Neural Networks (ANN) and Biological Neural Networks (BNN)

Characteristics	Artificial Neural Network (ANN)	Biological(Real) Neural Network (BNN)
Speed	Faster in processing information. Response time is in nanoseconds.	Slower in processing information. The response time is in milliseconds.
Processing	Serial processing.	Massively parallel processing.
Size & Complexity	Less size & complexity. It does not perform complex pattern recognition tasks.	A highly complex and dense network of interconnected neurons containing neurons of the order of 10 ¹¹ with 10 ¹⁵ of interconnections.
Storage	Information storage is replaceable means replacing new data with an old one.	A highly complex and dense network of interconnected neurons containing neurons of the order of 10 ¹¹ with 10 ¹⁵ of interconnections.
Fault tolerance	Fault intolerant. Corrupt information cannot retrieve in case of failure of the system.	Information storage is adaptable means new information is added by adjusting the interconnection strengths without destroying old information.
Control Mechanism	There is a control unit for controlling computing activities	No specific control mechanism external to the computing task

releases it to the hidden layer, which is the second layer. In the hidden layer, each neuron receives input from the previous layer neurons, computes the weighted sum, and sends it to the neurons in the next layer. These connections are weighted means effects of the inputs from the previous layer are optimized more or less by assigning different-different weights to each input and it is adjusted during the training process by optimizing these weights for improved model performance.

2. RESEARCH METHODS

The research method used in this work is a quantitative research approach. The data gathered were the monthly record of plastic production over the month for three years. The selected prediction method was used to determine the predicted yields for the products under investigation employing artificial neural network in Matlab 2017 version is a method used to predict the production output of the plastic pipe products. Artificial Neural Network serves as a tool used to carry out the prediction of the product solutions under investigation.

2.1 Artificial Neural Network

Artificial neural networks (ANNs) or connectionist systems are computing systems inspired by the biological neural networks that constitute animal brains. Such systems learn (progressively improve performance on) tasks by considering examples, generally without task-specific programming. An artificial neural network is an interconnected group of nodes, akin to the vast network of neurons in a brain. Here, each circular node represents an artificial neuron and an arrow represents a connection from the output of one artificial neuron to the input of another. An ANN is based on a collection of connected units or nodes called artificial neurons [15]. "Each connection (analogous to a synapse) between artificial neurons can transmit a signal from one to another. The artificial neuron that receives the signal can process it and then signal artificial neurons connected to it. In common ANN implementations, the signal at a connection between artificial neurons are real number, and the output of each artificial neuron is calculated by a non-linear function of the sum of its inputs. Artificial neurons and connections typically have a weight that adjusts as learning proceeds. The weight increases or decreases the strength of the signal at a connection. Artificial neurons may have a threshold such that only if the aggregate

signal crosses that threshold is the signal sent. Typically, artificial neurons are organized in layers. Different layers may perform different kinds of transformations on their inputs. Signals travel from the first (input), to the last (output) layer, possibly after traversing the layers multiple times" [16]. "The original goal of the ANN approach was to solve problems in the same way that a human brain would. Over time, attention focused on matching specific mental abilities, leading to deviations from biology. ANNs have been used on a variety of tasks, including computer vision, speech recognition, machine translation, social network filtering, playing board and video games and medical diagnosis" [17]. Neural network are data mining tool for finding unknown patterns in databases, a neural network is a massively parallel distributed processor that has a natural propensity for storing experimental - knowledge and making it available for use. It resembles the brain in two respects. Knowledge is acquired by the network through a learning process, Interneuron connection strengths known as synaptic weights are used to store the knowledge.

"An elementary neuron with R input is weighted with an appropriate w . The sum of the weighted inputs and the bias forms the input to the transfer function/.' Neurons can use any differentiable transfer function /to generate their output. Multilayer networks often use the log-sigmoid transfer function logsig. The function logsig generates outputs between 0 and 1 as the neuron's net input goes from negative to positive infinity. Alternatively, multilayer networks can use the tan-sigmoid transfer function tansig. Sigmoid output neurons are often used for pattern recognition problems, while linear output neurons are used for function fitting problems" [18]. "We study artificial intelligence as intelligent character and we want to know how computer perform the intelligent character. It can be divided in two parts. One is symbolism, and the other is connectionism. For symbolism, intelligence uses symbols and for connectionism, intelligence uses network connections and associated weights. Both have been applied in practical problems. Connectionism follow brain metaphor, therefore intelligence is interconnected by many processing elements in which any individual processing element has simple computational task. The weights are encoded for acquiring knowledge of a network. Multi-layered perceptions are most common and widely used method. The artificial neural network is based on connectionism. Now a day's artificial neural

network is dominant upon symbolism, because it can achieve knowledge and manipulate easily” [19,20]. Neural network comes out from biological terms and how the intelligent character suit to construction of artificial intelligent system. In artificial neural network, we study how to implement the intelligent character into the system as neuron like construction in brain.

2.2 Data Collection

Essentially, the primary source of data was from the company production records. Data were collected based on the company’s case study production yield. The production quantities of the company were collected on a daily record, weekly record, monthly record, quarterly record and yearly record. The data was generated based on the company’s production quantity of different products. The average record of the employees and the average efficiency of the machines were also recorded to analyze the effect of the employees to production quantity. The environmental factors were also factored in, as some of the records developed to achieve and analyze the influence of the production quantity of the products in the system. The data collected will reveal the results of what the production quantity data portrays and will support decision making system. Data were also gathered from direct observations from the manufacturing industry while the researcher was involved in daily production for a period of one month and

two weeks. The table 2 showed the data collected as follows.

2.3 Analysis and Results of the Input Factors and Production Output Quantities

Table 2 shows the data collected from the case company and also the environmental factors that influence the production rate. The data were collected over the period of three years from 2020 to 2022. The data collected is on extrusion plastic pipe.

Fig. 3 shows the data validation and testing using artificial neural network system. The application of artificial neural network (ANN) was used to train the data, validate the data and test the data. The data training is presented to the network during training and the network is adjusted according to its errors. The data validation was used to measure network generalization and to halt training when generalization stops improving. The data testing is used to show the effect on training and so provide an independent measure of network performance during and after training.

Fig. 4 shows the neural network training process and neural network analysis. It shows that the training system applies a Levenberg- Marquardt algorithm method. The mean square error algorithm is used to evaluate the performance analysis of the artificial neural network.

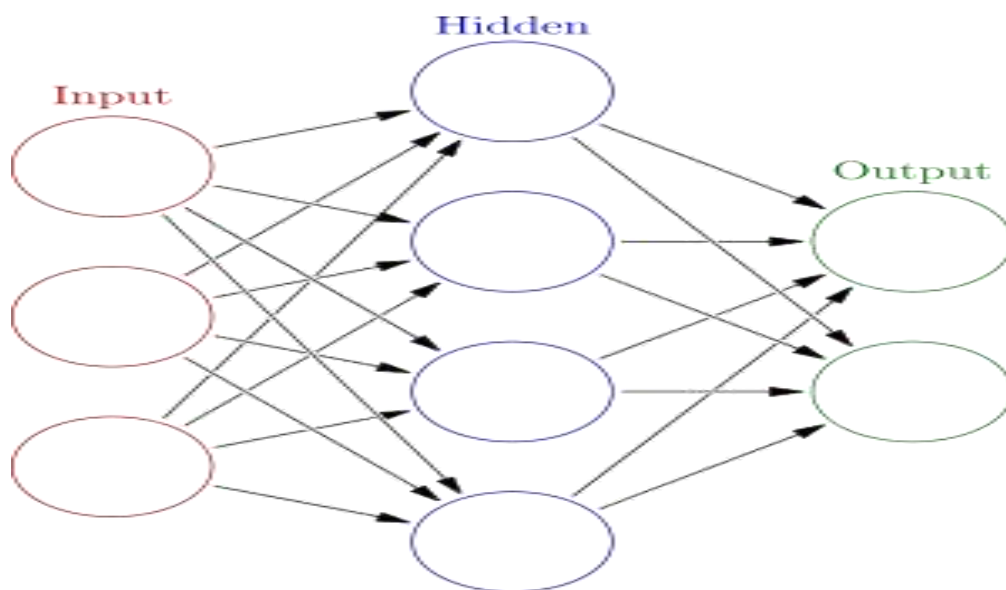

Fig. 2. Artificial Neural Network Diagram

Table 2. Presentation of 2020-2022 Monthly Data collection

Months	Temp. (°C)	R.R (mm)	R.H (%)	Employees (unit)	Z1	Z2	Z3	Z4
2020, Jan	28.55	15.4	61.17	17	21149	25171	3412	12891
Feb	29.7	18.8	65.68	18	20911	14708	2619	12736
March	30.3	70.3	69.23	18	30673	17124	3990	14146
April	28.95	130.1	71.97	13	15434	21570	4794	17877
May	28.6	217.2	74.65	13	17196	17252	4946	18608
June	27.1	251.9	82.23	15	15957	16825	3711	17471
July	27.1	241.7	83.1	16	20718	14197	3788	11897
Aug	26.4	237.1	82.42	16	21480	13864	4113	16426
Sept	26.7	292	82.95	14	15241	12408	4446	10385
Oct	27.1	200.9	68.96	17	16002	15313	3774	9204
Nov	28.9	12.1	66.05	19	18764	2707	3720	10858
Dec	28.25	7.7	67.65	19	18525	20618	2867	11763
2021, Jan	29	13.2	62.28	15	21012	19480	2347	19119
Feb	29.8	40.6	65.68	21	22208	20102	7607	12089
March	29.55	84.3	79.23	21	14106	23117	4567	16564
April	28.25	146.3	81.97	18	14485	19831	8067	11980
May	28.3	202.4	84.65	13	15997	18961	7757	18233
June	26.4	315.5	82.23	15	24111	14350	10829	13649
July	26.15	243	83.1	16	29080	12887	6027	15012
Aug	26.2	121.7	82.42	19	16964	13233	6827	12143
Sept	27.05	160	84.22	18	17281	19887	4317	17070
Oct	26.4	125.1	78.12	18	15600	16524	1287	15173
Nov	28.7	39.7	72.13	20	20614	20257	5501	13964
Dec	27.9	14.8	71.54	20	14374	10563	7515	11231
2022, Jan	28.78	12.4	59.02	15	22102	11158	8535	19208
Feb	29.26	26	66.4	18	21117	10224	6108	13997
March	29.93	77.3	71.5	19	18831	16527	5206	14154
April	29.47	148.2	81.01	14	22155	11892	5485	10096
May	28.98	227.8	79.75	13	15992	18272	7997	7640
June	27.2	288.7	82.45	15	24131	13766	6117	9321
July	26.62	254.45	91	18	26380	23002	7980	2976
Aug	26.51	219.4	81.5	16	17515	17281	5964	18579

Months	Temp. (°C)	R.R (mm)	R.H (%)	Employees (unit)	Z1	Z2	Z3	Z4
Sept	26.92	226	84.3	17	18435	19031	8280	8052
Oct	27.2	163	77.21	19	22208	21212	5400	4113
Nov	28.81	25.9	69.5	21	24617	16964	8124	5061
Dec	28.12	13.2	63.55	20	28742	17281	2374	6105

Source: Finoplastika grouped data
 Z1= 110mm Waste pipe, Z2= 20mm pressure pipe, Z3= 50mm Waste pipe, Z4= 32mm Pressure pipe

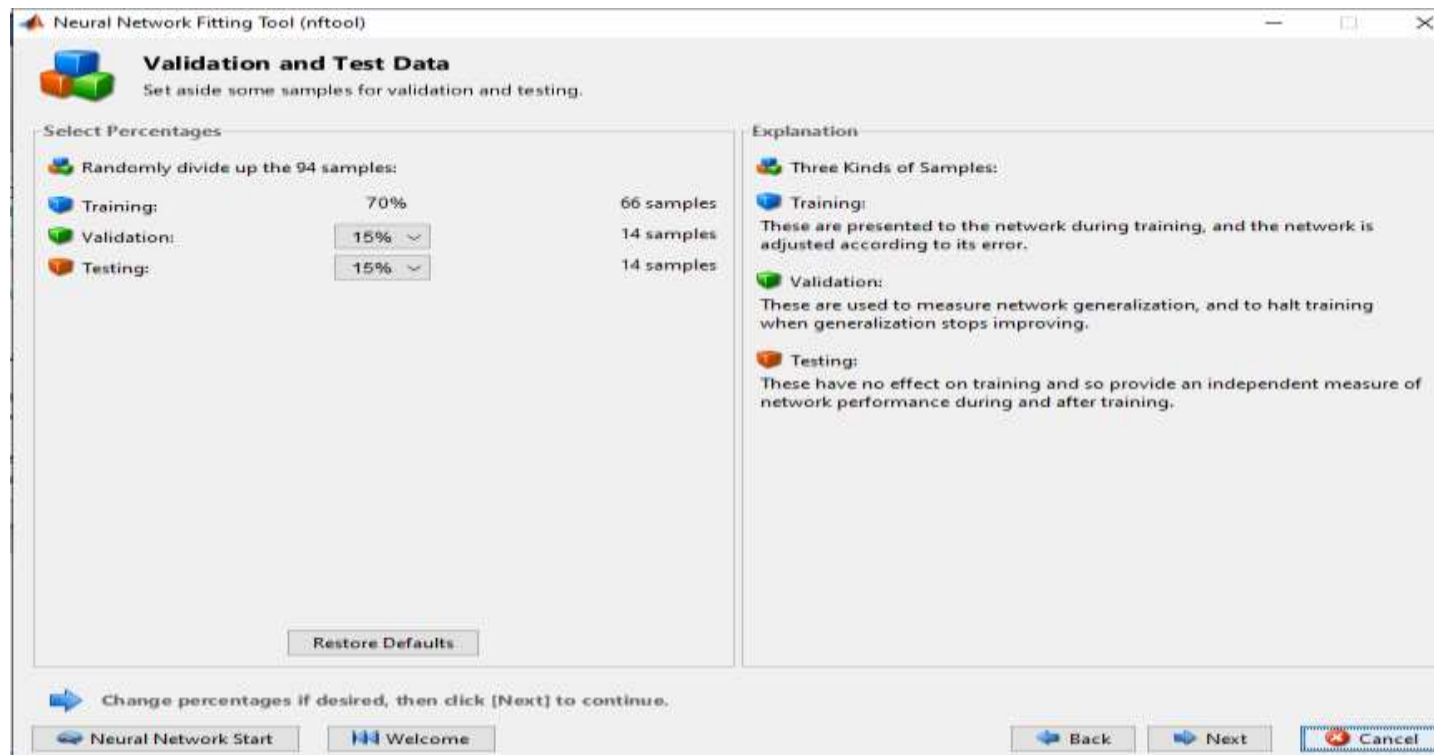

Fig. 3. Data Validation and Testing Using Neural Network tool

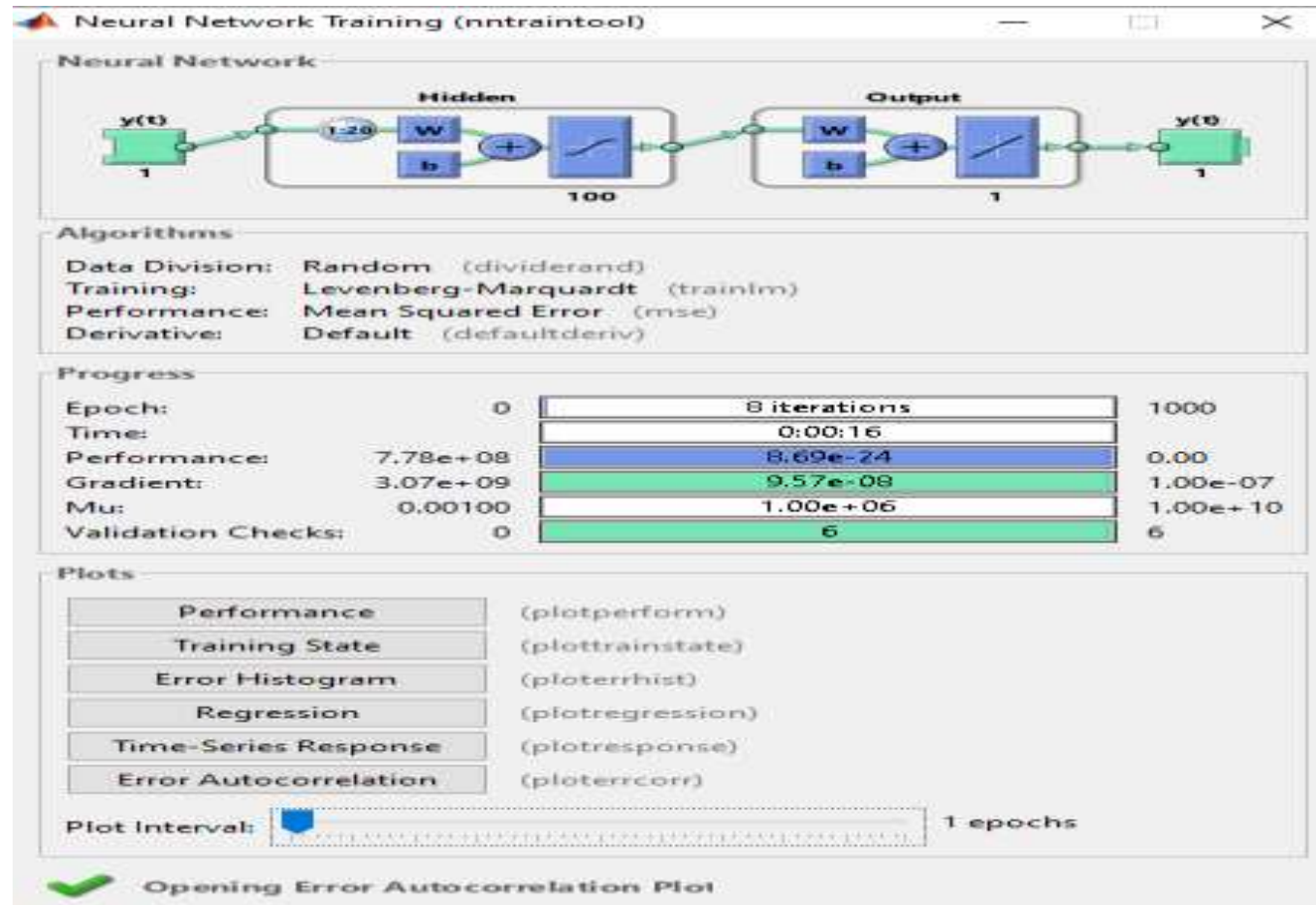

Fig. 4. Neural Network Training Process and analysis

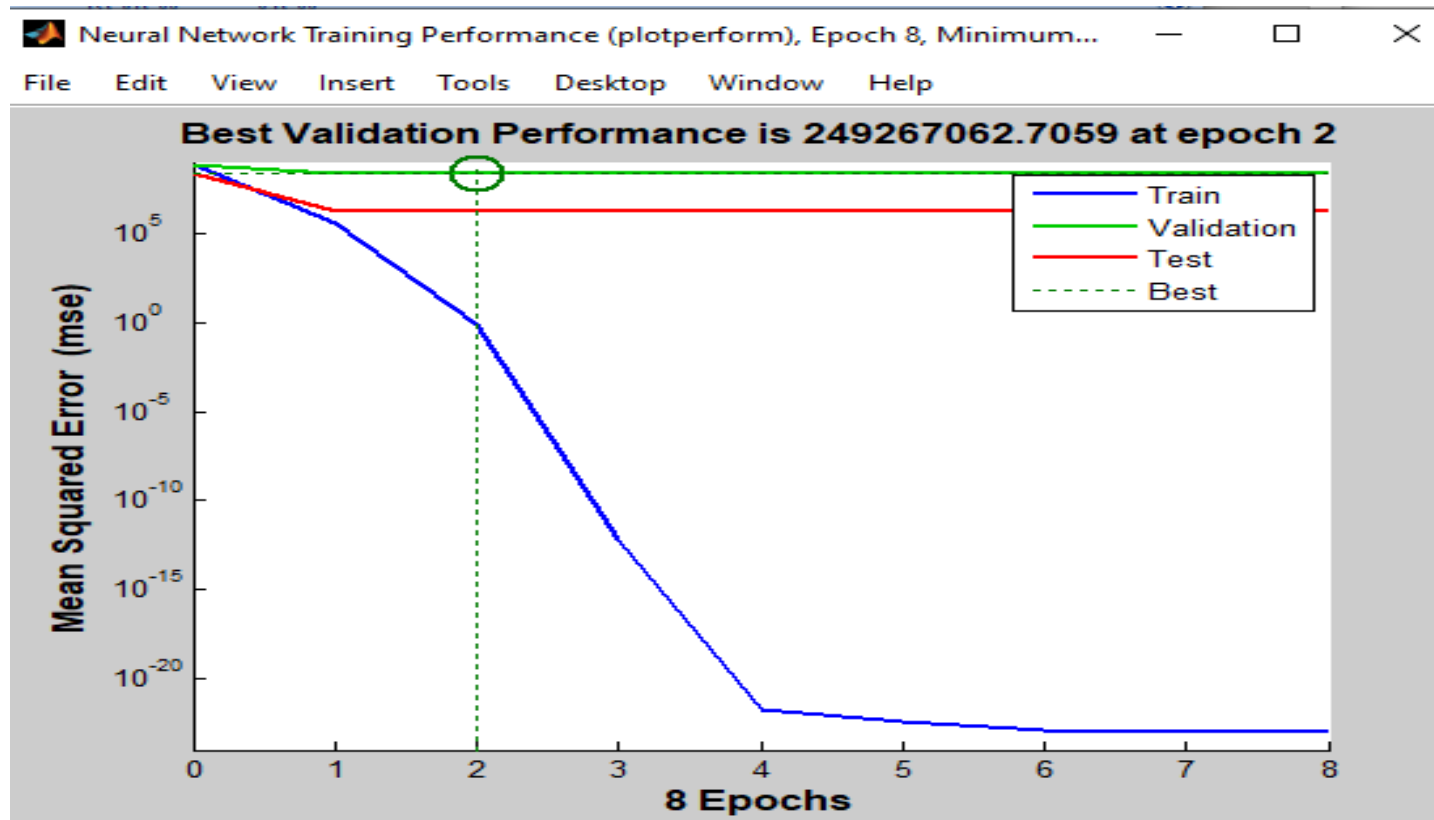

Fig. 5. Validation Performance Analyses

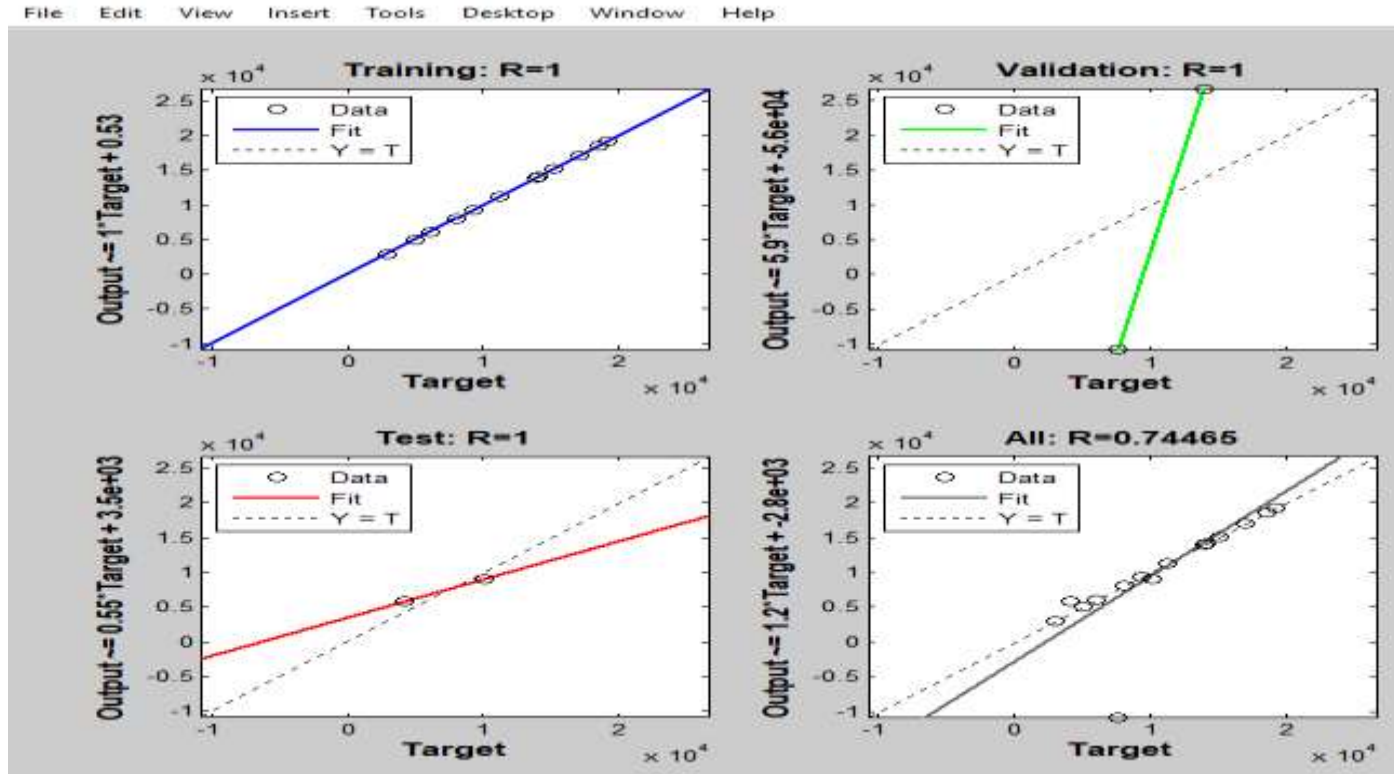

Fig. 6. Analyses of the Response Variables Targets

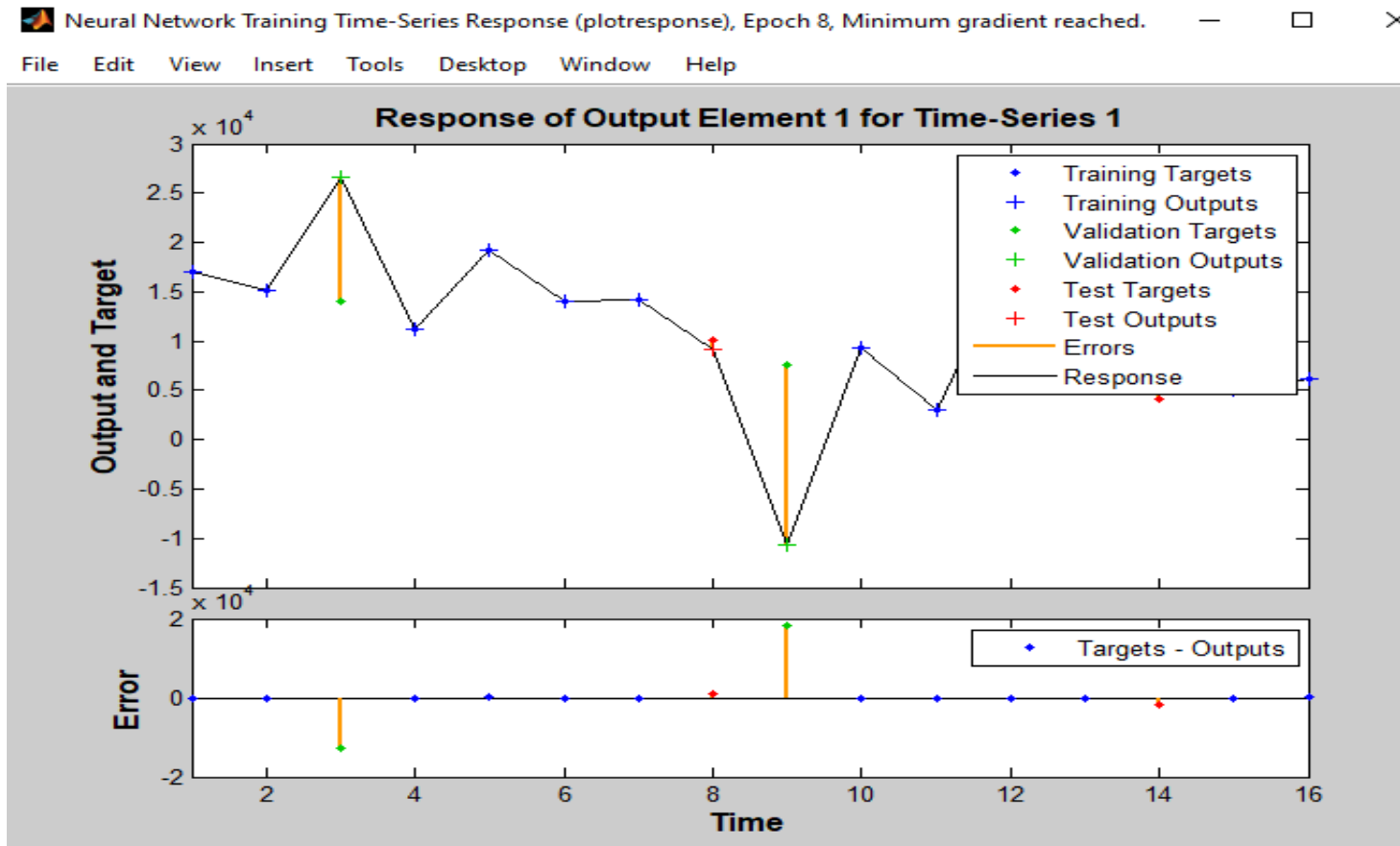

Fig. 7. Response of the Output variables and the Predicted Target

Table 3. Predictive Solutions for the response Parameters and input Factors

RH	RR	Temp	Employee	Z1	Z2	Z3	Z4
61.17	15.4	28.55	17	31149	45171	13412	12891
65.68	18.8	29.7	18	20911	14708	2619	12736
69.23	70.3	30.3	18	30673	17124	3990	14146
71.97	130.1	28.95	13	15434	21570	4794	17877
74.65	217.2	28.6	13	17196	17252	4946	18608
82.23	251.9	27.1	15	15957	16825	3711	17471
83.1	241.7	27.1	16	20718	14197	3788	11897
82.42	237.1	26.4	16	21480	13864	4113	16426
82.95	292	26.7	14	15241	12408	4446	10385
68.96	200.9	27.1	17	16002	15313	3774	9204
66.05	12.1	28.9	19	18764	2707	3720	10858
67.65	7.7	28.25	19	18525	20618	2867	11763
62.28	13.2	29	15	21012	19480	2347	19119
65.68	40.6	29.8	21	22208	20102	7607	12089
79.23	84.3	29.55	21	14106	23117	4567	16564
81.97	146.3	28.25	18	14485	19831	8067	11980
84.65	202.4	28.3	13	15997	18961	7757	18233
82.23	315.5	26.4	15	24111	14350	10829	13649
83.1	243	26.15	16	29080	12887	6027	15012
82.42	121.7	26.2	19	16964	13233	6827	12143
84.22	160	27.05	18	17281	19887	4317	17070
78.12	125.1	26.4	18	15600	16524	1287	15173
72.13	39.7	28.7	20	20614	20257	5501	13964
71.54	14.8	27.9	20	14374	10563	7515	11231
59.02	12.4	28.78	15	22102	11158	8535	19208
66.4	26	29.26	18	21117	10224	6108	13997
71.5	77.3	29.93	19	18831	16527	5206	14154
81.01	148.2	29.47	14	22155	11892	5485	10096
79.75	227.8	28.98	13	15992	18272	7997	7640
82.45	288.7	27.2	15	24131	13766	6117	9321
91	254.45	26.62	18	26380	23002	7980	2976
81.5	219.4	26.51	16	17515	17281	5964	18579
84.3	226	26.92	17	18435	19031	8280	8052

RH	RR	Temp	Employee	Z1	Z2	Z3	Z4
77.21	163	27.2	19	22208	21212	5400	4113
69.5	25.9	28.81	21	24617	16964	8124	5061
63.55	13.2	28.12	20	28742	17281	2374	6105

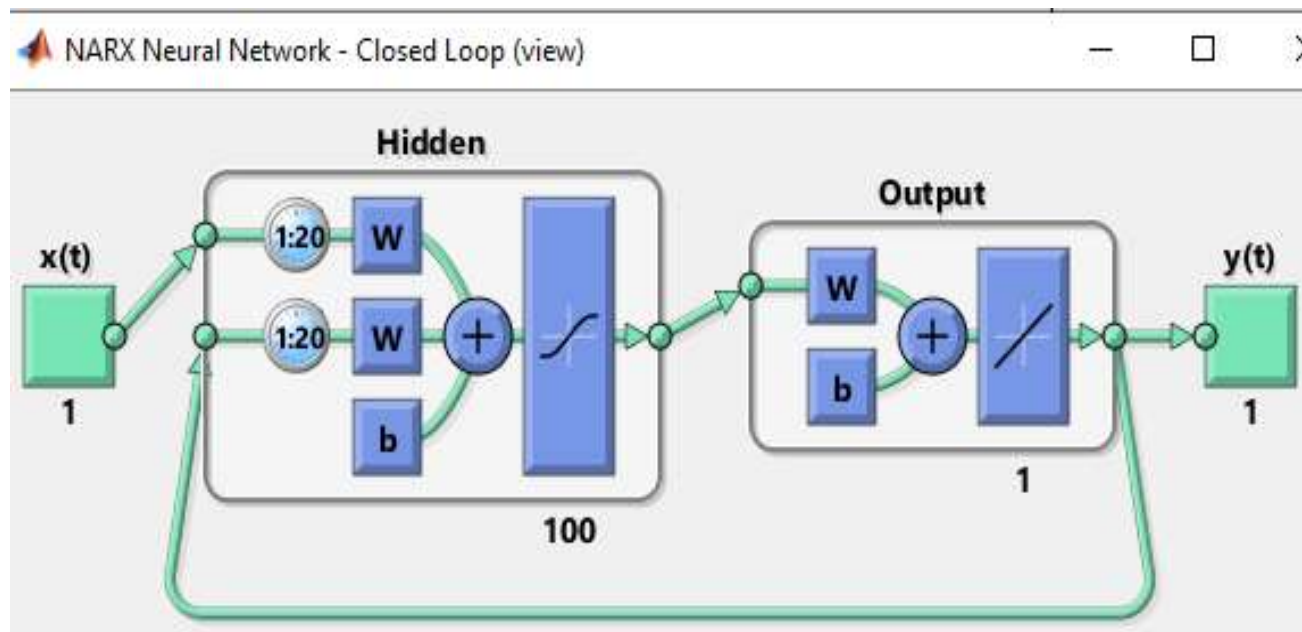

Fig. 8. Neural Networks Close Loop

Fig. 5 shows the best neural network validation performance. The epoch trials were performed eight (8) times to achieve the best validation performance. However, the best performance was achieved at the second epoch trial. The mean square error (MSE) was used to validate the performance analysis in the system. Training multiple times will generate different results due to different initial conditions and sampling. Mean Squared Error is the average squared difference between outputs and targets. Lower values are better. Zero means no error. Regression R Values measure the correlation between outputs and targets. An R value of 1 means a close relationship, 0 a random relationship.

Fig. 6 shows the target of the response variables. It evaluates the data fitness on data training, data validation, data testing and overall data performance of the response parameters in the system. The data training shows that the data training is relationship is unity. The data validation shows that the data validation is relationship is unity. The data testing shows that the data testing is relationship is unity.

Fig. 7 shows the response variables output and target over a period of time. It also shows the training, validation and testing outputs along with their targets. It further determines the errors between the output and the targets for the trained validated and testing data over a period of time.

The table above shows the predicted responses of the response variables. The table 3 shows the predictions developed with artificial neural network algorithm. The appropriate predicted results were revealed in the Table 3.

Fig. 8 shows the closed loop of the artificial neural network system. It shows the input factors and the output variables in the system

3. RESULTS AND DISCUSSION

The discussion of result is based on the analysis, results, tables and charts developed in this study. Figure 3 shows the data testing output using artificial neural network system. The application of artificial neural network (ANN) was used to train the data, validate the data and test the data. The data training is presented to the network during training and the network is adjusted according to its errors. The data validation was used to measure network generation and to halt training when generalization stops improving.

The data testing is used to show the effect on training and so provide an independent measure of network performance during and after training. Figure 4 shows the neural network training process and neural network analysis. It shows that the training system applies a Levenberg-Marquardt algorithm method. The mean square error algorithm is used to evaluate the performance analysis of the artificial neural network. Figure 5 shows the best neural network validation performance. The epoch trials were performed eight (8) times to achieve the best validation performance. However, the best performance was achieved at the second epoch trial. The mean square error (MSE) was used to validate the performance analysis in the system. Training multiple times will generate different results due to different initial conditions and sampling. Mean Squared Error is the average squared difference between outputs and targets. Lower values are better. Zero means no error. Regression R Values measure the correlation between outputs and targets. An R value of 1 means a close relationship, 0 a random relationship. Figure 6 shows the target of the response variables. It evaluates the data fitness on data training, data validation, data testing and overall data performance of the response parameters in the system. The data training shows that the data training is relationship is unity. The data validation shows that the data validation is relationship is unity. The data testing shows that the data testing is relationship is unity. Figure 7 shows the response variables output and target over a period of time. It also shows the training, validation and testing outputs along with their targets. It further determines the errors between the output and the targets for the trained validated and testing data over a period of time. The table 3 shows the predictions developed with artificial neural network algorithm. The appropriate predicted results were revealed in the table as shown above. The optimal results developed with response surface and that of artificial neural network tools are close which means that the results are achievable and more of reality.

4. CONCLUSION

The study has established clearly the optimal solutions of the factors and the responses used in the system. The models applied to achieve the results are response surface method and artificial neural network tools. The response optimal solutions using the artificial neural network tool the optimal solutions for the response variables

for 110mm waste plastic pipe, 20mm pressure plastic pipe, 50mm waste plastic pipe and 32mm pressure plastic pipe the predicted results as 31149, 45171, 13412, and 12891 respectively. This shows that the predicted solutions and the results are achievable. The results for predicted solutions are recommended to the case company and other plastic companies for their wider use and applicability in order to achieve their optimal results and to support decision making during production planning and control.

COMPETING INTERESTS

Authors have declared that no competing interests exist.

REFERENCES

- Ezeliora CD, Umeh MN, Mbeledeogu NN, Ezeokonkwo JU. Improving the productivity of small and medium scale industries using linear programming model: International Journal of Scientific & Engineering Research. 2014;5(1):2009-2025. January-2014 ISSN 2229-5518.
- Ezeliora CD, Obiafudo O. 'The Optimization of Production Cost using Linear Programming Solver; Journal of Scientific and Engineering Research, 2015;2(3):13-21 Available online ISSN: 2394-2630 CODEN (USA): JSERBR
- Okpala CD, Nwuba EIU, Nwajinka CO, Ezeliora CD, Okonkwo CC. Geospatial Mapping, Modelling and Optimization of Modular Rice Aggregation Centers in Anambra Zone. Journal of Engineering and Applied Sciences. June 2021. JEAS ISSN: 1119-8109. 2021;18(1):297-305.
- Liao J, Wu C, Liu Y. The role of biodegradable plastics in solving plastic waste problems. Frontiers in environmental science. 2020;8:590882. DOI: 10.3389/fenvs.2020.590882
- Andrady AL. Microplastics in the marine environment. Marine pollution bulletin, 2017;119(1):12-22. DOI: 10.1016/j.marpolbul.2017.01.082
- Ezeliora CD, Nwakobi JO, Agu SP. Appraisal of Optimal Production Quantity in Small and Medium Scale Industry; International Journal of Advanced Engineering Research and Technology (IJAERT). 2017;5(1).2348 –8190. Available: www.ijaert.org
- Geyer R, Jambeck JR, Law KL. Production, use, and fate of all plastics ever made. Science advances, 2017;3(7): e1700782. DOI: 10.1126/sciadv.1700782
- Stevens ES. Green plastics: An introduction to the new science of biodegradable plastics. Princeton, NJ: Princeton University Press; 2017.
- Kumar A, Singh SP. Recent developments in bioplastics and their biodegradation. ACS Sustainable Chemistry & Engineering. 2019;7(7):6646-6683. DOI: 10.1021/acssuschemeng.9b01156
- Ezeliora CD, Umeh MN, Dilinna AM. Investigation and Optimization of Production Variables: A Case of Plastic Manufacturing Industry. Journal of Engineering Research and Report., 2020; Article no.JERR.56495; ISSN: 2582-2926. 2020;15(1):1-16. DOI: 10.9734/JERR/2020/v15i117134
- geeksforgEEKS.org. Artificial Neural Networks and its Applications – Geeks for Geeks; 2023. Available: <https://www.geeksforgEEKS.org/artificial-neural-networks-and-its-applications/> Last Updated: 02 Jun, 2023
- xenonstack.com. Artificial Neural Networks Applications and Algorithms xenonstack.com; 2023 Available: <https://www.xenonstack.com/blog/artificial-neural-network-applications>
- Xu ZJ, Zhang Y, Xiao Y. "Training Behavior of Deep Neural Network in Frequency Domain". In Gedeon T, Wong K, Lee M (eds.). Neural Information Processing. ICONIP 2019. Lecture Notes in Computer Science. Vol. 11953. Springer, Cham. 2019;264–274. arXiv: 1807.01251. DOI:10.1007/978-3-030-36708-4_22.ISBN 978-3-030-36707-7. S2CID 49562099.
- Chen J. What Is a Neural Network?; 2023 Available: <https://www.investopedia.com/terms/n/neuralnetwork.asp>. Updated April 30, 2023
- Sheetal S. Artificial Neural Network (ANN) in Machine Learning; 2017 Available: <https://www.datasciencecentral.com/artificial-neural-network-ann-in-machine-learning/>. August 8, 2017 at 3:00 pm
- Auer, Peter; Harald Burgsteiner; Wolfgang Maass. "A learning rule for very simple universal approximators consisting of a single layer of perceptrons" (PDF). Neural Networks; 2008;21 (5):786–795. PMID: 18249524;

- DOI:10.1016/j.neunet.2007.12.036_
17. Zell, Andreas. Simulation Neuronaler Netze [Simulation of Neural Networks] (in German). Addison-Wesley. 1994;1:73. ISBN 3-89319-554-8.
 18. Roman M. Balabin; Ravilya Z. Safieva; Ekaterina I. Lomakina. "Comparison of linear and nonlinear calibration models based on near infrared (NIR) spectroscopy data for gasoline properties prediction". Chemometr Intell Lab. 2007;88 (2):183–188. DOI:10.1016/ j.chemolab.2007.04.006
 19. Tahmasebi, Pejman; Hezarkhani, Ardeshir. "Application of a Modular Feedforward Neural Network for Grade Estimation". Natural Resources Research. 2011;20 (1):25–32. DOI:10.1007/s11053-011-9135-3
 20. Tahmasebi; Hezarkhani. "A hybrid neural networks-fuzzy logic-genetic algorithm for grade estimation". Computers & Geosciences. 2012;42:18–27. Bibcode: 2012CG. 42 18T. DOI:10.1016/j.cageo.2012.02.004. PMC 4268588. PMID:25540468.

© 2023 Chukwuebuka et al.; This is an Open Access article distributed under the terms of the Creative Commons Attribution License (<http://creativecommons.org/licenses/by/4.0>), which permits unrestricted use, distribution, and reproduction in any medium, provided the original work is properly cited.

Peer-review history:
The peer review history for this paper can be accessed here:
<https://www.sdiarticle5.com/review-history/109393>